

MAGNETIC GRIPPER

SERIES HM1000

▶ PRODUCT ADVANTAGES



▶ **Secure hold during EMERGENCY STOP**

Magnets attached to springs ensure your workpiece remains secure, even during a drop in pressure



▶ **Contact plate that increases friction value**

The replaceable O-ring ensures the high dynamics in your application and protection of your workpiece

▶ **Residual holding force < 1N**

The demagnetised contact surface safeguards the process reliability of dropping off your workpiece

▶ SERIES CHARACTERISTICS

Installation size	Version
HM10XX	NC
 5 million maintenance-free cycles (max.)	●
 IP30	●



► BENEFITS IN DETAIL

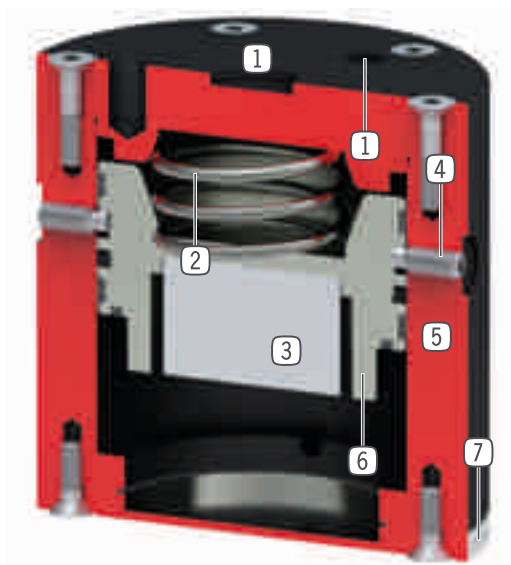

- ① **Mounting and positioning**
 - via centering sleeve and thread
- ② **Spring**
 - for piston return
 - secured holding even in drop pressure
- ③ **Permanent magnet**
 - requires no power supply
 - high holding forces
- ④ **Transport safeguarding**
- ⑤ **Robust, lightweight housing**
 - Hard-coated aluminum alloy
- ⑥ **single-acting pneumatic cylinders**
 - only one pneumatic line required
 - Spring return
- ⑦ **Contact plate**
 - easy replaceable
 - embedded O-ring to increase the friction coefficient

► TECHNICAL DATA

Installation size	Adhesive force max.	Weight	IP class
	[N]	[kg]	
HM1030	27	0.06	IP30
HM1046	65	0.28	IP30
HM1078	220	1.2	IP30
HM1097	450	2.2	IP30

► FURTHER INFORMATION IS AVAILABLE ONLINE



All information just a click away at: www.zimmer-group.com. Find data, illustrations, 3D models and operating instructions for your installation size using the order number for your desired product. Quick, clear and always up-to-date.

MAGNETIC GRIPPER

INSTALLATION SIZE HM1078

▶ PRODUCT SPECIFICATIONS



▶ INCLUDED IN DELIVERY

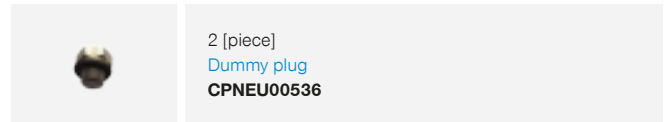
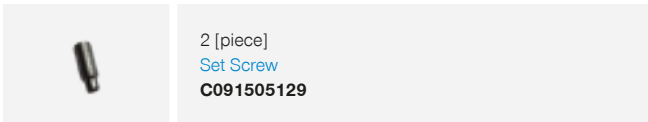

▶ RECOMMENDED ACCESSORIES



ENERGY SUPPLY



GV1-8X8
Straight Fittings - Quick Connect Style



CONNECTIONS / OTHER



KG60ST
Ball Joints Steel



CONNECTIONS / OTHER



KG60
Ball Joints



ZE15H7X4
Centering Disc

Order no.	▶ Technical data
	HM1078NC
Adhesive force max. [N]	220
Operating pressure min. [bar]	3
Operating pressure max. [bar]	8
Operating temperature min. [°C]	5
Operating temperature max. [°C]	+80
Air volume per cycle [cm ³]	75
Weight [kg]	1.2

